

MULTI STABILIZED OUTDOOR DETECTOR

VX-402, VX-402REC

Standard model Voice Warning model

**2 YEAR WARRANTY**

FEATURES

- Voice Warning Function (VX-402REC Only)** VX-402REC is capable of delivering two kinds of audible messages to an intruder. This has been proven as an effective means of deterring BREAK-INS.
- Easy Recording with Built-in microphone or External apparatus (VX-402REC Only)** The VX-402REC detector records warning messages by either of two different ways: speak direct to its built-in microphone or connect an external sound source to the detector.
- Limited Detection Range Function** The detection range of the VX-402 can be limited to avoid detecting unwanted objects. By limiting the detection range, false alarms due to unwanted movement (i.e. cars, persons or animals outside the protected area) can be reduced.
- Size Judging Function** VX-402 is designed to discriminate between large and small animals. By utilizing this ability, false alarms due to small animals can be reduced.
- Bright Light Disturbance Immunity** VX-402 is equipped with Double Conductive Shielding (Patent Listed). This shielding greatly reduces the chance of false alarms due to car headlights, sunlight and other ambient light sources.
- Detection Area Extension Function** The detection area can be easily extended by using its slave units.
- Directional Detection Function** VX-402 can distinguish movement direction by using slave units. This function increases the operational reliability and allows for use in new applications (Directional Security).

CONTENTS

1.INSTALLATION HINTS	2
2.DESCRPTION AND OPERATION	3
3.INSTALLATION	4
4.WIRING	5
5.RECORDING	6
6.SETTING & ADJUSTMENTS	7
7.FUNCTIONS	10
8.OPERATION TEST	13
9.TROUBLE SHOOTING	14
10.SPECIFICATIONS	16
11.DIMENSIONS	16

Safety-Related Precautions

- Before installation, make sure to read this instruction manual carefully for safe and effective product operation.
- After reading this installation manual, make sure to keep it in a convenient place for future use.

⚠ Warning	This icon denotes a situation involving the risk of serious injury or even death, if the warning given is ignored.
⚠ Caution	This icon denotes a situation involving the risk of serious injury or damage to property if the warning given is ignored.



This icon indicates actions to be avoided. Details of the actions to be avoided are written beside or near icon.



This icon indicates instructions that should be strictly followed.

⚠ Warning	Never use this product for any application except purpose for detecting moving target such as a human or a car. In addition, never use for any activation for a shutter or other. It may cause hazards.	
⚠ Warning	To avoid the risk of electric shock, never touch the main body of the product with wet hands. (Also, if the product is wet after rain do not touch it.)	
⚠ Warning	Never attempt to disassemble or modify the product, which increases the risk of fire or damage of the product.	
⚠ Warning	Never attempt to connect the terminals to units which require higher power supply or current draw than its rating. It increases the risk of fire or damage to the product.	
⚠ Caution	Avoid applying water in directly from brackets, houses, or otherwise splashing water directly onto the product. It increases the risk of damaging the product.	
⚠ Caution	Clean and inspect the device periodically for safe operation. If any defect is detected, ask your local supplier to repair the device.	

1.INSTALLATION HINTS

1. Install the sensor perpendicular to the ground making upper detection area parallel to the ground.

If the sensor is installed with some angle to the ground, operational reliability of the sensor may be decreased.

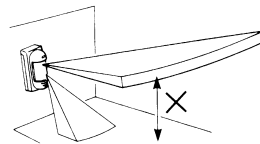
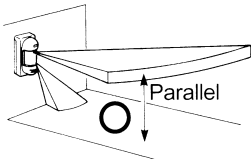

2. Installation height is 0.8m-1.2m (2.7ft-4ft)

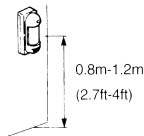

3. Mount the sensor so that a majority of traffic flow is across the detection pattern.

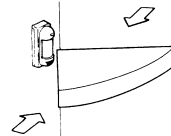

4. VX-402 is designed to protect any light disturbances. However, too much light may cause unstable condition with the sensor, such as; strong sunlight directed or reflected exactly into the sensor's field of view. It is recommended to avoid such installation.

5. Avoid pointing the sensor towards moving objects (i.e. swaying trees, bushes, flags, etc.). If moving objects are unavoidable, please refer to Trouble Shooting reference for proper installation.

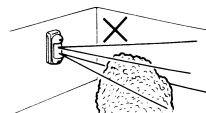
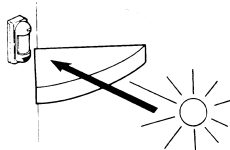

2. DESCRIPTION AND OPERATION

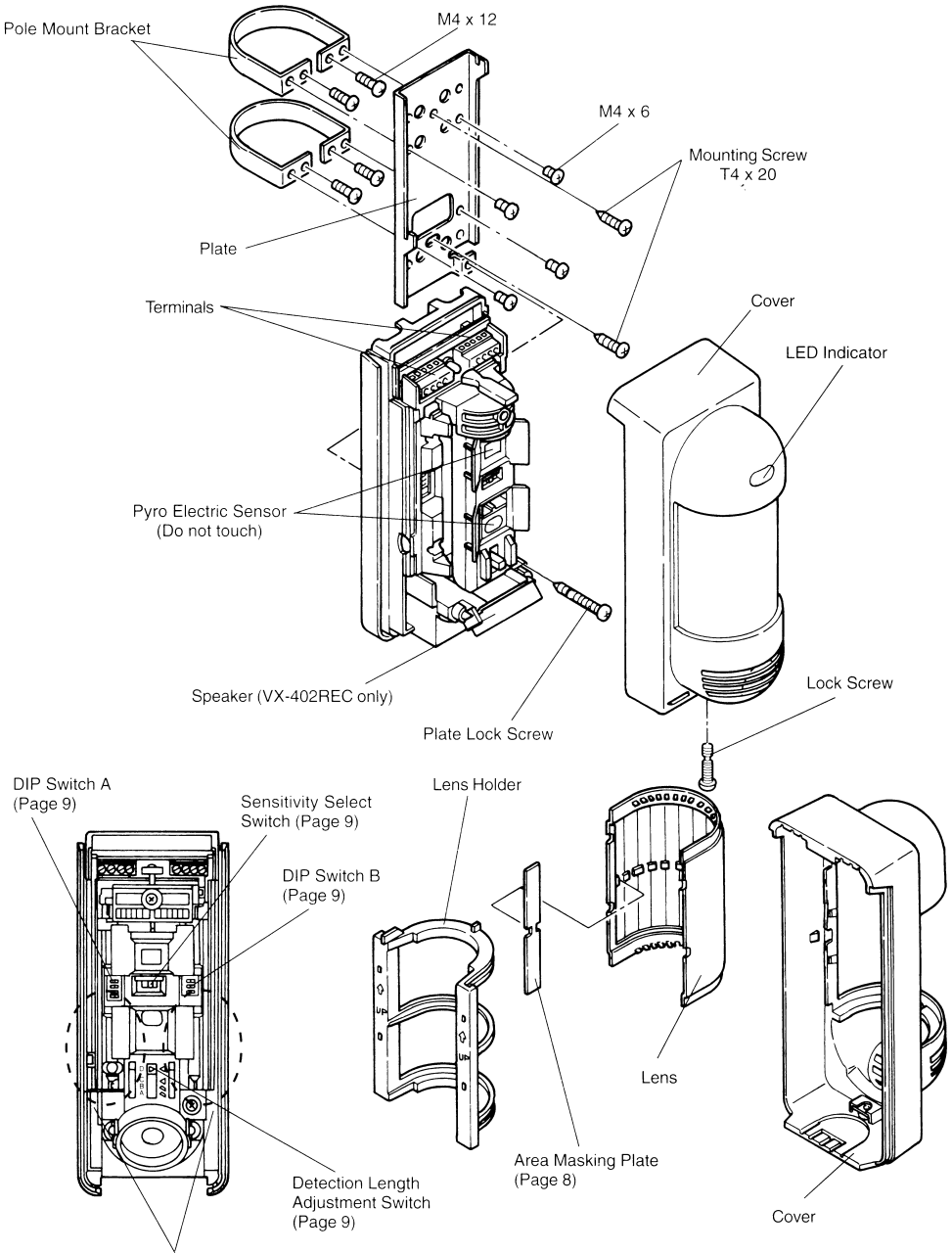

There are switches only for VX-402REC in this portion (Page 6, 9)

3.INSTALLATION

3-1.Before the Installation

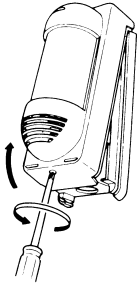

Loosen the lock screw and remove the cover.

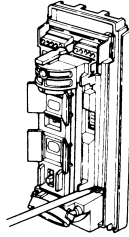

Loosen the plate lock screw [about 10mm (0.4)].

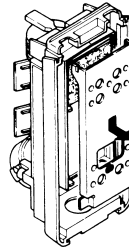

Remove the plate by sliding it down and away from the unit base.

3-2.Wall Mount

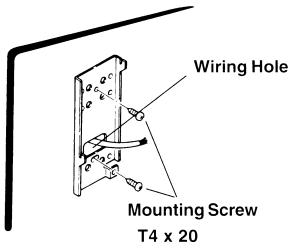

Pull the wire through wiring hole and install the plate on the wall by using provided mounting screws (two places).

IMPORTANT

- Install the unit perpendicular.
- Installation height must be between 0.8m and 1.2m (2.7 ft and 4 ft).
- Secure a space 110mm (4.4") or more to the upper part of plate for opening and closing of the cover.

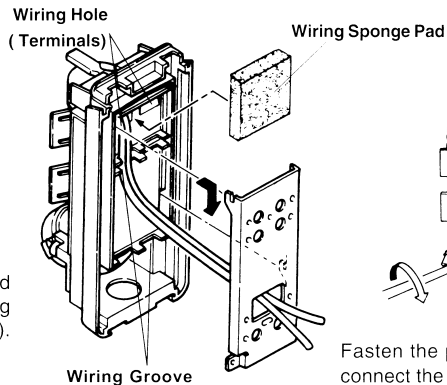

Lead the wire to the groove on the unit base, through the wiring hole at the terminals. Apply an adhesive sponge pad over the wiring hole. Hook the unit base onto the plate.

Fasten the plate lock screw and connect the wires to the terminal.

Adjust the DIP switch, detection area and sensitivity. Secure the cover with the lock screw.

Surface wiring

(a)Upper Knockout Wiring Hole

Remove the upper wire knockout.

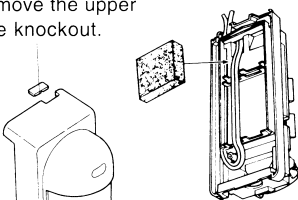

Lead the wire through the upper side of the unit base, lead the wire to the wiring slit then through the wiring hole.

(b)Lower Knockout Wiring Hole

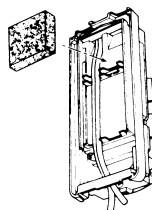

Remove the lower knockout of the unite cover, lead the wire through the knockout hole.

3-3.Pole Mount

An installation pole with an outside diameter of 43mm(1.66") must be used. (Standard U.S. 1 1/4 "pipe has an outside diameter of 1.66".)

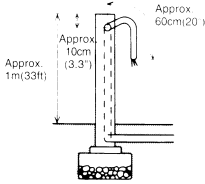

For outdoor wiring, bury piping as deep as possible. Some sites will require metal coated cables for underground wiring work. Avoid aerial wiring

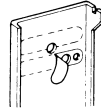

Peel off one of the two sealings along the dotted line.

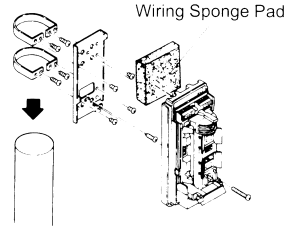

Fix bracket onto mounting plate with supplied screws (M4x6,4pcs). Place the bracket around the pole and tighten firmly with pole locking screws.

3-4.Electric Box Mount

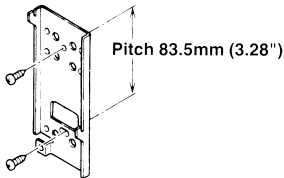

For connections to single gang electric boxes, follow instructions for wall mounting.

3-5.Conduit Installation

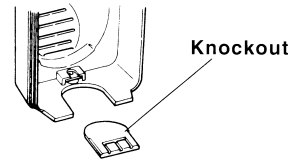
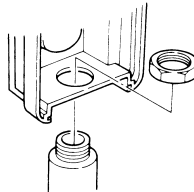

Conduit can be installed directly into the bottom of the unit by removing the knockout on the bottom on the cover.

4.WIRING

VX-402

POWER INPUT:9.5 - 18VDC

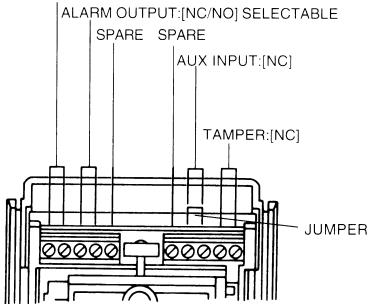

VX-402REC

POWER INPUT:9.5 - 18VDC

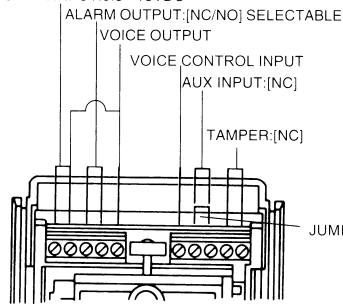

IMPORTANT

- Do not remove jumper while slave is not connected.
- Use AUX INPUT terminal only when slave is used.

Power wires should not exceed the following lengths.

WIRE GAUGE	VX-402		VX-402REC	
	12V	14V	12V	14V
AWG 22(0.33mm ²)	200m(670ft)	400m(1330ft)	110m(370ft)	230m(770ft)
AWG 20(0.52mm ²)	340m(1130ft)	640m(2130ft)	180m(600ft)	360m(1200ft)
AWG 18(0.83mm ²)	510m(1700ft)	1020m(3400ft)	290m(970ft)	570m(1900ft)

5.RECORDING

The VX-402REC detector records warning messages by either of two different ways: speak direct to its built-in microphone or connect an external sound source (tape-recorder or computer etc.) to the detector.

5-1.Description for Recording

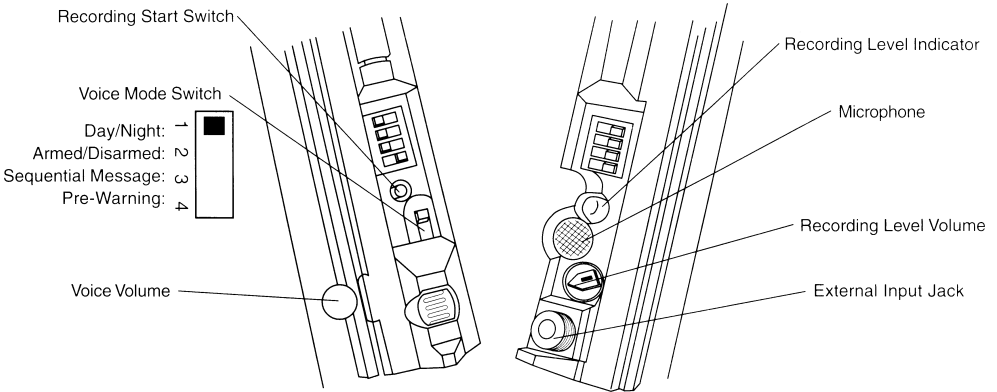

5-2.Recording Method

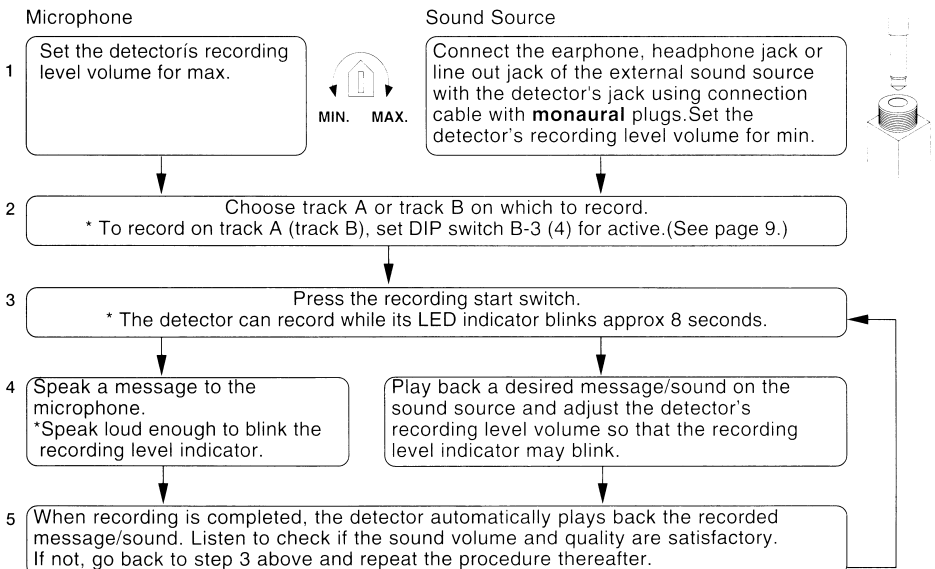

IMPORTANT

- Do not record big volume from the beginning, which could overload and damage the speaker.
- Do not record the sound of chimes or a siren, which could overload and damage the speaker.
- For connection with sound source, use the plug which suited for the jack form of the apparatus.
- A blinking recording level indicator shows that an adequate sound volume has been ensured. If reproduced sound is heard broken, adjust the sound level with the detector's recording level volume or the sound source's volume controller.

6.SETTING & ADJUSTMENTS

6-1.Detection Length Adjustment

Press and slide the Detection Length Adjustment Switch to the desired position.

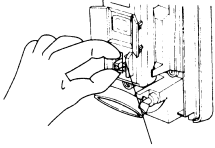

Detection Length Adjustment Switch

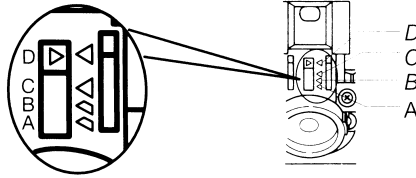

Side view of detection pattern

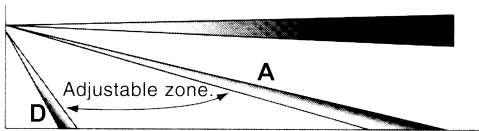

Length of Lower Detection Area decides detection length

The upper detection area stays parallel to the ground at all time. The lower detection area moves as shown above depending on the switch position. So, length of the detection is limited by the length of lower detection area, since both upper & lower detection area have to be blocked at the same time to activate the sensor.

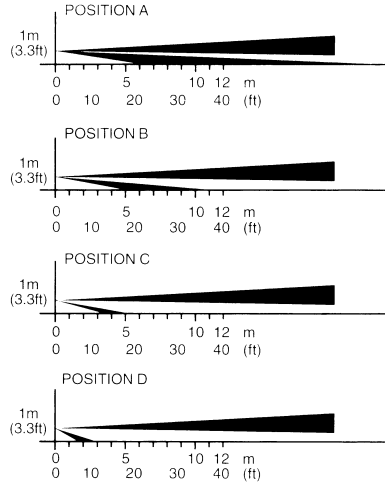

IMPORTANT

BOTH DETECTION AREA MUST BE BLOCKED FOR DETECTION

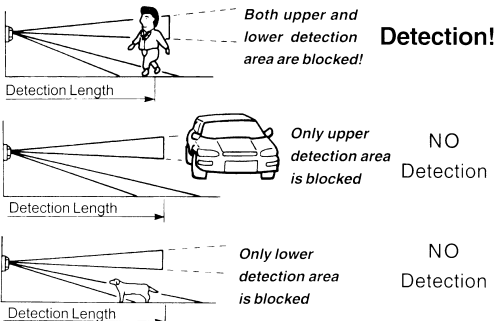

Detection Length setting chart Instration Height=1m(3.3ft)

POSITION	MAX DETECTION LENGTH	
	Standard	*
A	12.0 (40.0)	10.0 - 15.0 (33.3 - 50.0)
	8.0 (26.7)	6.0 - 10.0 (20.0 - 33.3)
C	5.0 (16.7)	4.0 - 5.5 (13.3 - 18.3)
	2.0 (6.7)	1.5 - 2.5 (5.0 - 8.3)

*The maximum detection length may vary as above due to environmental thermal conditions.

IMPORTANT

If there is a traffic near the detection area, please adjust detection 1.5m to 2.0m(5ft to 7ft) away from movements.
(See section 8 OPERATION TEST on page 13 for the details.)

6-2.Area Angle Adjustment

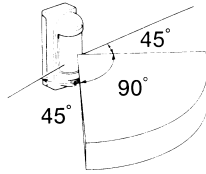
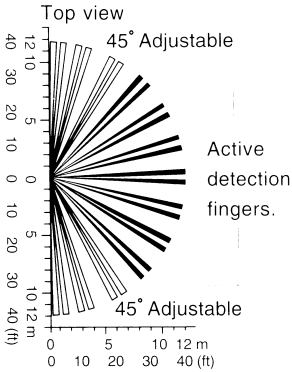

Area angle is 90° with 7 fingers by 15° Turn optical cylinder. Angle moves by 15° per notch.

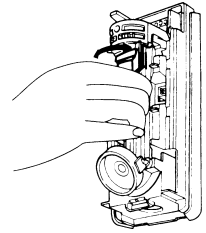

Hold the pyro electric unit and turn it to the desired direction (15° steps).

6-3.Area Masking

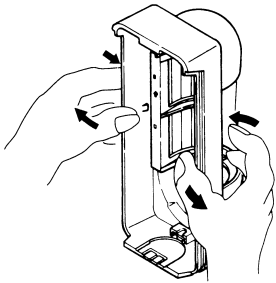

1. Remove the lens holder from the cover as shown above.

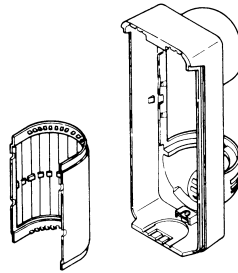

2. Separate the lens from the cover.

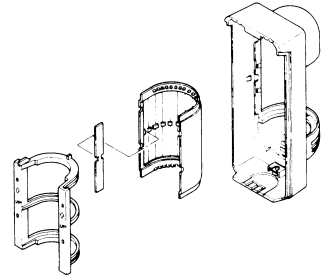

3. Apply the provided area masking plate to the inside of the lens on the zone to be eliminated.

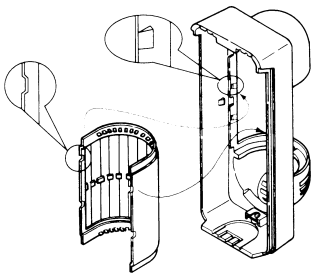

4. Put the lens back in by aligning the 4 projections on the cover to the 4 cut outs on the lens.

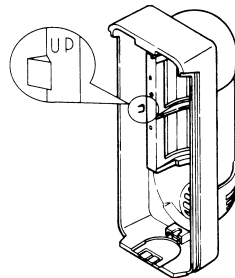

5. Place the lens holder. Confirm the lens holder is held by left and right prongs on the cover.

IMPORTANT

As shown at left, the active detection fingers are always 7, if the area masking plate is not applied.

The active fingers are varied by area adjustment as explained at left.

Please make sure which fingers are active before applying area masking plate.

6-4.Sensitivity Adjustment

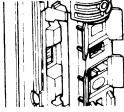

Sensitivity Select Switch (L.M.H)

When greater sensitivity is desired, select "H". When the installation site is poor (bad conditions) select "L".

6-5.Voice Warning Function Setup (VX-402REC only)

1. Choosing a playback mode

The VX-402REC detector provides several playback modes.(See section7 on page 10-12.) Choose the desired mode using the voice mode switch.

2. Message selection and recording

Choose and record a message suitable for the function to be used. For message selection, operate the DIP switch B. (See section 6-6.)

3. Volume adjustment

Voice
Volume

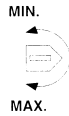
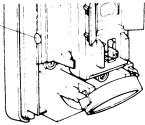

Adjust the voice volume by turning the adjustment .

4. External speaker

An external speaker may be connected to the VX-402REC detector to thunder the intruder away.

Wiring Diagram

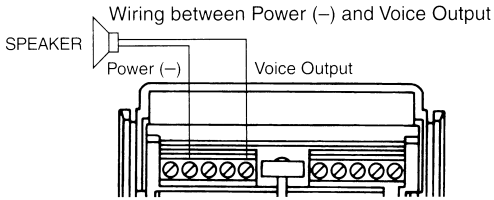

IMPORTANT

- Recommended speaker Impedance : 8 Ω
- Max power : over 30W
- Output S.P.L: over 90dB/m
- Weatherproof
- Speaker with amplifier can not be used.
- Wiring length AWG18(0.83mm²): 10 m

6-6.DIP Switch Setup

DIP SWITCH A

DIP SWITCH B

VX-402

DETECTABLE DIRECTION:
ALARM OUTPUT:
DIRECTIONAL DETECTION:
DAY/NIGHT MODE:

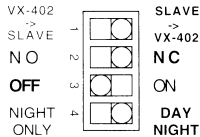

OFF ON :LED INDICATOR
2 4 :PULSE COUNT

VX-402REC

DETECTABLE DIRECTION:
ALARM OUTPUT:
STATUS SELECT:
DAY/NIGHT MODE:

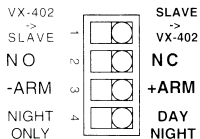

OFF ON :LED INDICATOR
2 4 :PULSE COUNT
ACTIVE PAUSE :MESSAGE A
ACTIVE PAUSE :MESSAGE B

IMPORTANT

When AUX INPUT is not connected, set as follows.

VX-402 :Set Directional Detection to OFF.

VX-402REC :Do not set a voice mode switch as Pre-Warning

7.FUNCTIONS

7-1.Two Detectors Mode

The functions of the VX-402 series can be extended by connecting components such as outdoor PIR's, active IR beams or magnetic contacts to the AUX INPUT terminal.

Wiring Diagram

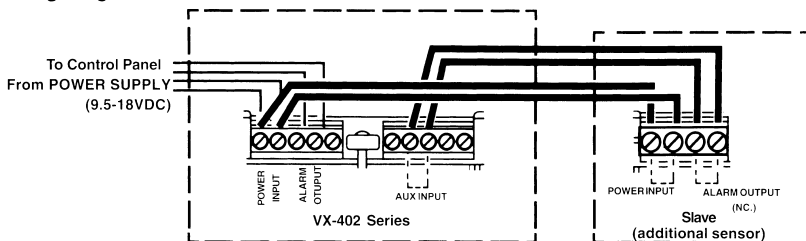

When a slave is connected,
Please remove the jumper.

7-1-1.Detection Area Extension Function (DIP switch A-3/Directional Detection:OFF)

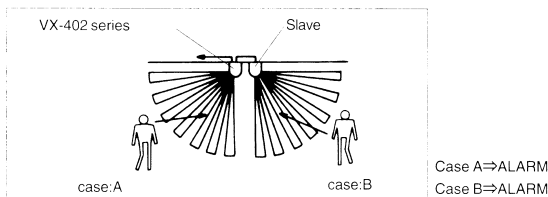

When the Directional Detection mode is selected OFF:

Alarm signal will be sent to the control panel when either VX-402 series or slave activates.

(In VX-402REC, do not set the voice mode switch as Pre-Warning.)

7-1-2.Direction Detection Function (DIP switch A-3/Directional Detection:ON)

When the Directional Detection mode is selected ON:

Alarm signal will be sent to the control panel when both VX-402 series and slave activate. In this case, select the direction by the DIP switch A. (See section 6-6 on page 9.)

SLAVE -> VX-402 series :

When a person passes the SLAVE area then enters the area covered by the VX-402 series within 1 minute, the VX-402 series will activate.(See page 11.)

VX-402 series -> SLAVE :

When a person passes the VX-402 series area then enters the area covered by the SLAVE unit within 1 minute, the VX-402 series will activate. (See page 11.)

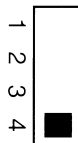

Voice Mode Switch

In VX-402REC, set the voice mode switch as Pre-Warning.

SLAVE -> VX-402 series :

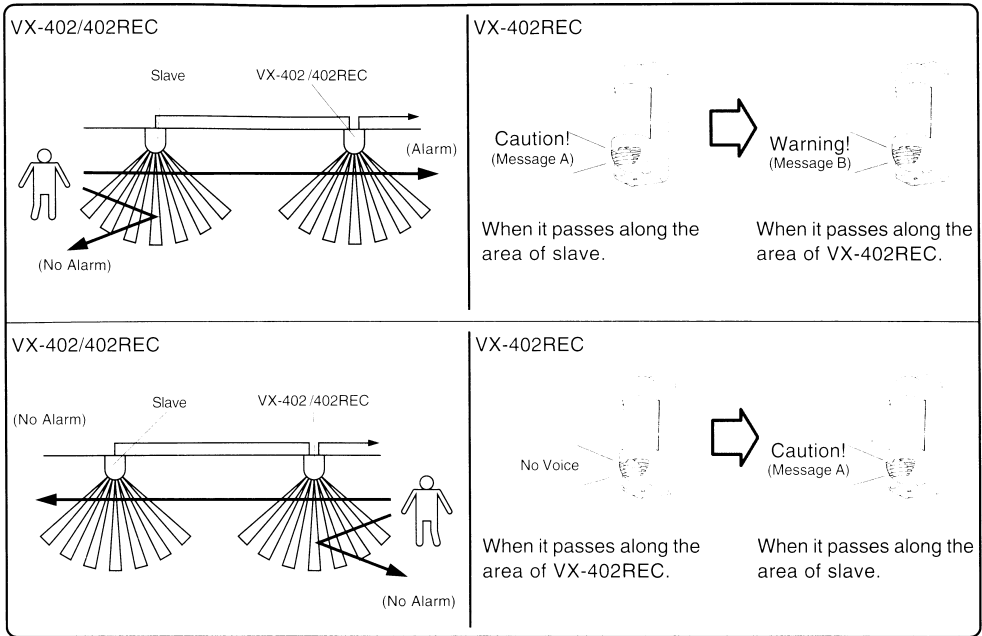

VX-402 series -> SLAVE :

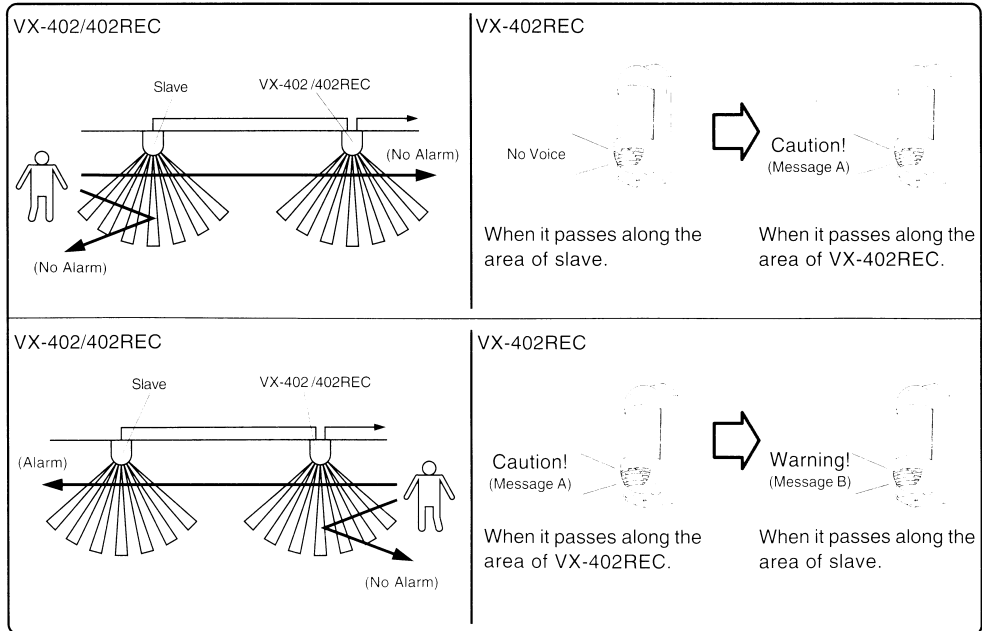

7-2.Day/Night Mode (VX-402REC only)

The detector will automatically change messages from that for the daytime to that for the night-time and vice versa.

Daytime : Message A
Night-time: Message B

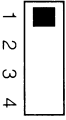

Voice Mode Switch



7-3.Arm/Disarm Mode (VX-402REC only)

The detector will sound different messages when it is set for the armed mode or disarmed mode.

Armed : Message A
Disarmed: Message B



Voice Mode Switch

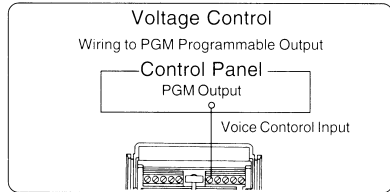
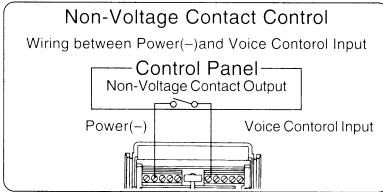
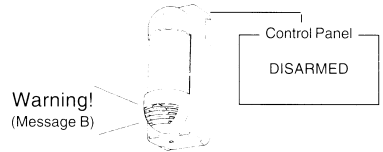
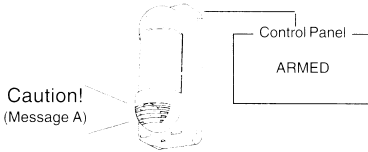

Detector Setting / Control Panel	+ARM		-ARM	
	Non-Voltage Contact Control	Voltage Control	Non-Voltage Contact Control	Voltage Control
Armed	DC 0 - 1V	DC 5 - 18V	DC 5 - 18V	DC 0 - 1V
Disarmed	DC 5 - 18V	DC 0 - 1V	DC 0 - 1V	DC 5 - 18V

7-4.Sequential Message Mode (VX-402REC only)

The detector automatically changes messages from A to B if the times of detection in the covered area exceed a preset count in a given duration of time.

Message A for normal detection.

Message B for unusual detection where the above condition is met.



Voice Mode Switch

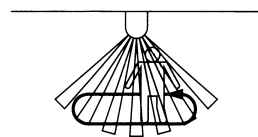
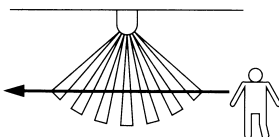
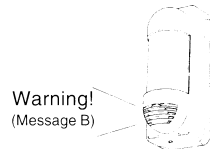
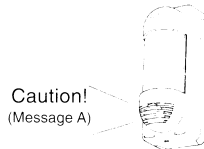

8. OPERATION TEST

1. Turn LED indicator on. (See page 9.)
2. Check and adjust the detection area. (See pages 7,8.)

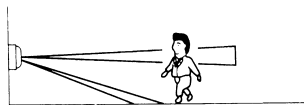

IMPORTANT!

- 1) When the car or person goes near the detection area (a), please adjust the detection area 1.5m to 2m (5ft to 7ft) shorter than movement area (b) and confirm by walk test. Because, the actual detection area may change from 1.5m to 2m (5ft to 7ft) due to the environmental thermal conditions.

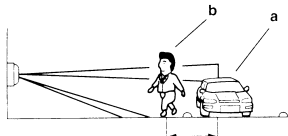

The detection area might increase when there is a big temperature difference between the moving object and the background.

Example

When around 13m (43ft) detection area is required as shown below.

- 1) If the detection length adjusted to **position A** [12m (40ft)], there is a possibility to detect the car, depending on the environmental thermal conditions.

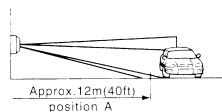

In such case,

- 1) Please adjust the detection length to **position B**. The detection length will be around 8m (27ft) which is rather shorter than ideal length but can remove the chance of false detection.
- 2) Confirm by walk test. **Detects at area a and no detection at area b.**

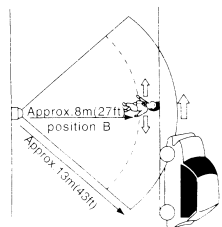
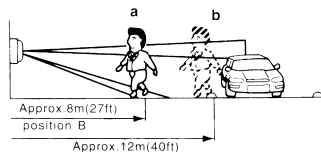

- 2) VX-402 has a multi-level detection pattern (from side view). A heat source beyond the detection area may cause the detector a false alarm by reflecting off the ground. Examples of reflective ground is water (puddle), wet road, smooth surface concrete and asphalt road. Reflection rate is not 100% of course on the ground, however, if the heat source is strong and / or reflection rate is high, detectors detection distance will be longer than required and may detect unwanted objects beyond. According to the ground condition of the installation site, select the detection range position.



9.TROUBLE SHOOTING

PROBLEM	DESCRIPTION	PROBABLE CAUSE	REMEDY
Detector fails to work.		Incorrect power supply voltage.	Set supply voltage for a range of 9.5 to 18 VDC.
	LED does not light.	LED switch is turned OFF.	Turn LED switch ON. (See section 6-6 on page 9.)
	Alarm is not outputted.	DIP switch A-4 is set for Night Only.	Set switch A-4 for Day/Night and see if it works. (See section 6-6 on page 9.)
		DIP switch A-3 (Directional Detection) is turned ON.	Turn OFF DIP switch A-3. (See section 6-6 on page 9.)
	Faulty wiring to detector.	Rewire alarm output correctly. (See section 4 on page 5.)	
LED blinks continuously		Incorrect power supply voltage.	Set supply voltage for a range of 9.5 to 18 VDC.
Make alarm continuously		Jumper is not connected to the AUX INPUT terminal.	Connect the jumper to the terminal. (See section 4 on page 5.)
Make alarms even though no moving object is in the area		Detector is not installed perpendicularly to the ground.	Reinstall the detector perpendicularly to the ground. (See section3-2 on page 4.)
		Lower detection area is unnecessarily long.	Confirm and reset the detection area. (See section6-1.2 on page 7.8.)
		Lower detection area receives reflected sunlight or car light, etc.	Remove the reflector or reset the detection area or mask the area exposed to reflected light. (See section6-1 - 3 on page 7.8.)
		Lower detection area is exposed to direct sunlight or car light.	Reset the area so it may not receive direct light. (See section6-1.2 on page 7.8.)
		There is any heat source (stove or heater, etc.) in the area that may cause temperature change.	Reset the area or remove the heat source. (See section6-1.2 on page 7.8.)
		There is any moving object (laundry on clothesline, plants, etc.) in the area.	Reset the area or remove moving objects. (See section6-1.2 on page 7.8.)
No detection occasionally		Detection area is not set appropriately.	Reset the area appropriately. (See section6-1.2 on page 7.8.)
		Sensitivity is set for L(ow).	Reset sensitivity for M(edium) or H(igh). (See section 6-4 on page 9.)

PROBLEM	DESCRIPTION	PROBABLE CAUSE	REMEDY
No message output.	No message at all.	Volume controller is set for Low.	Reset volume for an appropriate level. (See section 6-5 on page 9.)
		Voice control input is not wired correctly.	Wire the voice control input correctly. (See section 4 on page 5.)
		Set DIP switch B-3 (Message A) and DIP switch B-4 (Message B) for PAUSE.	Set DIPswitch B-3 and DIP switch B-4 for ACTIVE.(See section 6-6 on page 9.)
	Message A not displayed.	Set DIP switch B-3 for PAUSE.	Set DIP switch B-3 for ACTIVE. (See section 6-6 on page 9.)
	Message B not displayed.	Set DIP switch B-4 for PAUSE.	Set DIP switch B-4 for ACTIVE. (See section 6-6 on page 9.)
Recording fails.	Microphone dead.	Recording volume controller is not set for Max and recording level indicator does not blink during recording.	Set the controller for Max and make sure that the indicator blinks during recording. (See section 5-2 on page 6.)
	External sound source dead.	Connection cable is not suitable for monaural recording.	Use a monaural connection cable to connect the Detector to the earphone or headphone jack of the sound source. (See section 5-1,2 on page 6.)
		Cable is not connected to the earphone or headphone jack.	
	All recording functions dead.	Recording level indicator does not blink during recording.	Also, make sure that the indicator blinks during recording. Set either Track A (DIP switch B-3) or Track B (DIP switch B-4) for ACTIVE. (See section 5-1 on page 6.)
		Both DIP switch B-3 and B-4 are set for ACTIVE or PAUSE.	
Message A fails to record.		Not only DIP switch B-3 but also B-4 is set for ACTIVE.	
Message B fails to record.	Not only DIP switch B-4 but also B-3 is set for ACTIVE.	Set only DIP switch B-4 (Message B) for ACTIVE.(See section 6-6 on page 9.)	

10.SPECIFICATIONS

MODEL		VX-402	VX-402REC
Detection Method		Passive Infrared	
Coverage		12m(40ft)90° wide	
Detection Zones		14zones	
Mounting Height		0.8-1.2m(2.7-4ft)	
Sensitivity		2.0 C(3.6°F) at 0.6m/s	
Detectable Speed		0.3-1.5m/s(1-5ft/s)	
Power Input		9.5-18VDC	
Current Draw	NC	Normal 25mA Max 28mA	Normal 25mA Max 180mA
	NO	Normal 10mA Max 35mA	Normal 12mA Max 200mA
Alarm Period		2±1sec	
Alarm Output		Selectable N.C./N.O.; 28VDC 0.2A Max	
Tamper Switch		N.C. Opens when cover removed	
Pulse Count		20±5sec 2 or 4	
Warm-up Period		Approx 30sec(LED blinks)	
LED Indicator	LED blinking during warm-up period		
	Alarm condition		
	Recording condition		
Weatherproof		IP54	
Operating Temperature		-20 - +50°C(-4 - +122°F)	
Environment Humidity		95% Max	
RF Interference		No Alarm 30V/m	
Mounting		Wall, Pole, Conduit and Electric box	
Weight		550g(19.4oz)	
Accessories		Pole mount kit, Screw Kit, Area Masking Plate	

Note: Specifications and design are subject to change without prior notice.

11.DIMENSIONS

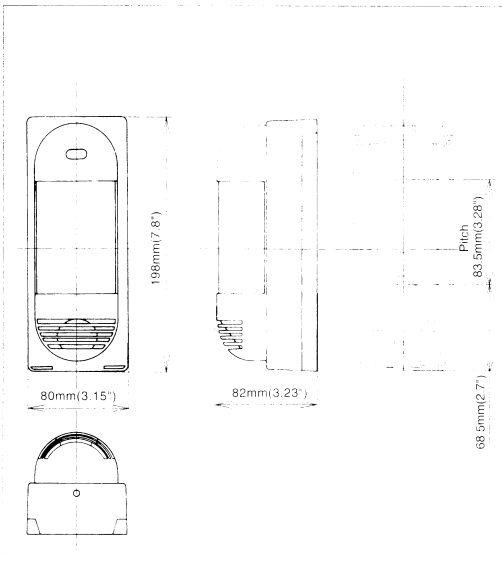

NOTE

This unit is designed to detect movement of an intruder and activate an alarm control panel.

Being only a part of a complete system, we cannot accept responsibility for any damages or other consequences resulting from an intrusion.

This Product conforms to the EMC Directive.89/336 EEC.



OPTEX CO., LTD. (ISO 9001 Certified by LRQA)
4-7-5 Nionohama Otsu, 520-0801 Japan
TEL (077)524-6047 FAX (077)522-9022

OPTEX INCORPORATED
1845W, 205th Street Torrance, CA 90501-1510 U.S.A.
TEL (310)533-1500 FAX (310)533-5910

OPTEX (EUROPE) LTD. (ISO 9002 Certified by NQA)
Clivemont Road, Cordwallis Park, Maidenhead, Berkshire, SL6 7BU U.K.
TEL (01628)631000 FAX (01628)636311